

Data Sheet



Article number: 586350215

Description: Ball Valve 350.215, G 2" - G 2"
Thread/Thread

Measures

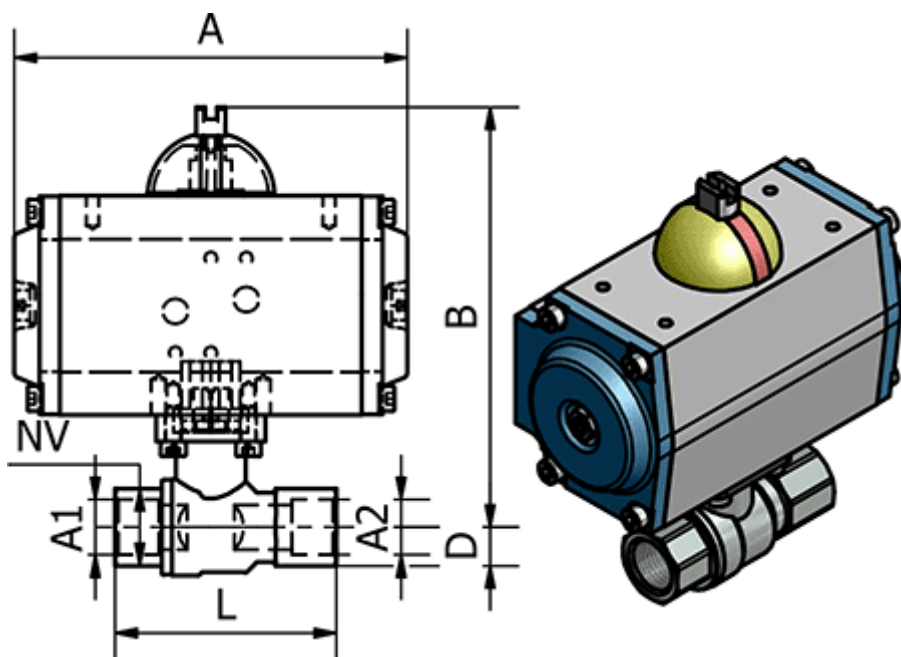

A	= 137
B	= 191
Connecting A1	= G 2"
Connecting A2	= G 2"
D	= 45
L	= 140
Max. Operating Pressure	= 25 bar
NV	= 70